



Instruction Manual

Washing Machine



Model numbers: RH1261TW

Please read these instructions carefully and keep them for future reference.

For Customer Services, Spare Parts & Manufacturer's Warranty Information, please call

01204 664 084

Opening times: Monday – Friday 9am – 5pm

Saturday: 9am – 1pm

Contents

| | |
|---|----|
| Before Use..... | 4 |
| Safety Warnings..... | 4 |
| Recommendations..... | 5 |
| Components..... | 5 |
| Front..... | 6 |
| Back..... | 6 |
| Installation..... | 6 |
| Removing transportation bolts..... | 7 |
| Levelling the machine..... | 8 |
| Electrical connection..... | 8 |
| Water inlet connection..... | 8 |
| Technical specifications..... | 10 |
| Preparing your laundry..... | 10 |
| Using your machine..... | 12 |
| Detergent..... | 12 |
| Control Panel..... | 13 |
| Detergent Drawer..... | 13 |
| Selecting a Programme..... | 14 |
| Electronic Display..... | 14 |
| Using your machine..... | 15 |
| Before Use..... | 15 |
| First Wash..... | 15 |
| Selecting a Programme..... | 15 |
| Additional Functions..... | 15 |
| Half Load Detection..... | 15 |
| Twinjet system..... | 16 |
| Programme selection..... | 17 |
| Additional Functions..... | 18 |
| 1. Spin Speed..... | 18 |
| 2. Temperature selection..... | 19 |
| 3. Pre Wash..... | 19 |
| 4. Rapid Wash..... | 19 |
| 5. Easy Iron..... | 20 |
| 6. Delay Timer..... | 20 |
| Anti-Allergy Function..... | 21 |
| Start/Pause button..... | 21 |
| Adding/Removing Laundry..... | 22 |
| Child Lock..... | 22 |
| Cancelling a Programme..... | 23 |
| Programme End..... | 23 |
| Warning Symbols..... | 24 |
| Water cut off / Low Mains Pressure..... | 24 |
| Blocked pump filter..... | 24 |
| Maintenance and Cleaning..... | 24 |
| Water Inlet Filters..... | 25 |
| Cleaning the pump..... | 25 |
| Cleaning the detergent drawer..... | 27 |
| Cleaning your machine..... | 27 |
| Trouble Shooting..... | 28 |

| | |
|-------------------------|----|
| Error Messages | 30 |
| Warning symbols | 31 |
| Energy Efficiency | 32 |

Before Use

Safety Warnings

- Do not use an extension lead for this appliance. Only plug directly into a wall socket.
- Do not plug in damaged plug sockets
- In case the power cable becomes damaged, contact **01204 664 084** for advice.
- Never pull the cable when unplugging – always grip the plug itself.
- Do not plug-in or pull-out the plug from the receptacle with wet hands to prevent electric shock.
- Never touch the machine with wet hands or feet.
- Never open the detergent drawer when the appliance is running.
- Never force the door to open when the washing machine is running.
- Do not touch discharging hose and water during discharging as the appliance may reach high temperatures when running.
- In case of any breakdown, unplug the appliance first and then turn the tap off. Do not attempt to repair by yourself, always contact **01204 664 084** for advice.
- Remember that packaging materials of your machine may be dangerous for children. Keep the packaging materials in a place where children cannot reach or dispose of them appropriately.
- Do not allow your children to play with the washing machine as it is an electrically-driven appliance.
- Keep your pets away from your machine.
- Your machine should only be used by adults in line with the information provided in this user's manual.
- Your machine is designed to be used domestically. Commercial use will cause your warranty to be cancelled.
- Anyone's intervention to your machine except for a qualified engineer, in anyway will cause your warranty to be invalid.
- Ideal operating temperature of your machine is 15-25°C.
- Do not place your machine on carpet as this will block ventilation of the base.
- Do not keep inflammable liquids near your machine.
- You should remove the transport bolts of your machine before the first usage. Faults occurring in machines operated with transport bolts fitted are not covered by the warranty.
- Do not put the discharging hose of your machine in a bucket or sink.
- Your machine is not covered under warranty for faults caused by any kind of external factors (pesticides, fire, etc.).
- The appliance is not intended for use by people (including children) with reduced physical, sensory or mental capabilities, or lack of experience and knowledge unless they have been given supervision or instruction concerning use of the appliance by a person responsible for their safety. Children should be supervised to ensure that they do not play with the appliance.

Recommendations

- **Ensure you run the machine empty on a full cycle at 95°C with detergent before using the machine properly for the first time.**
- Put detergent into the drawer at the beginning of each wash.
- It is recommended that you wash only extremely dirty laundry in prewashing programme.
- The amount of laundry you put in your washing machine should not exceed 6kg.
- If your machine is not going to be used for a long time you should unplug the appliance, turn off the water inlet and leave the door slightly open. This is so that the inside of your machine will remain dry and will not cause an unpleasant smell of damp.

Components

Front

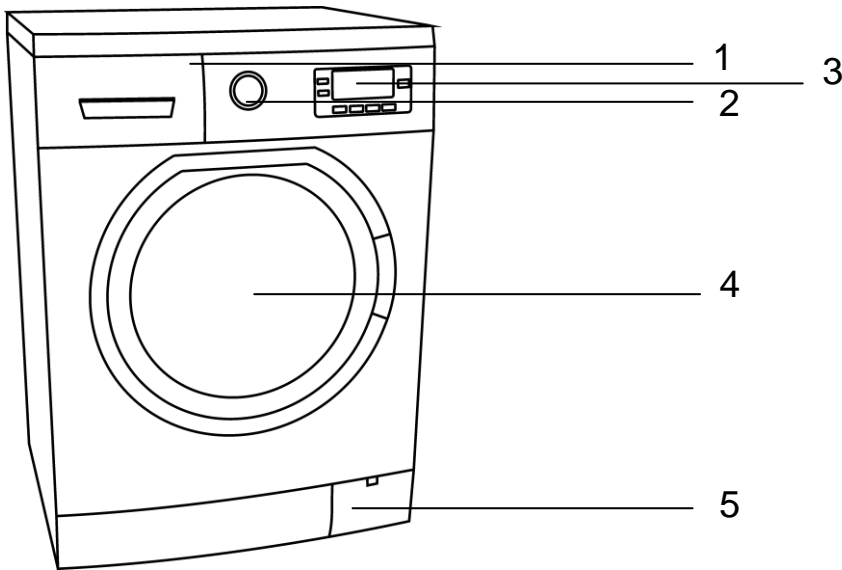

- 1. Detergent drawer
- 2. Programme knob
- 3. Electronic display
- 4. Door
- 5. Cover of pump filter

Back

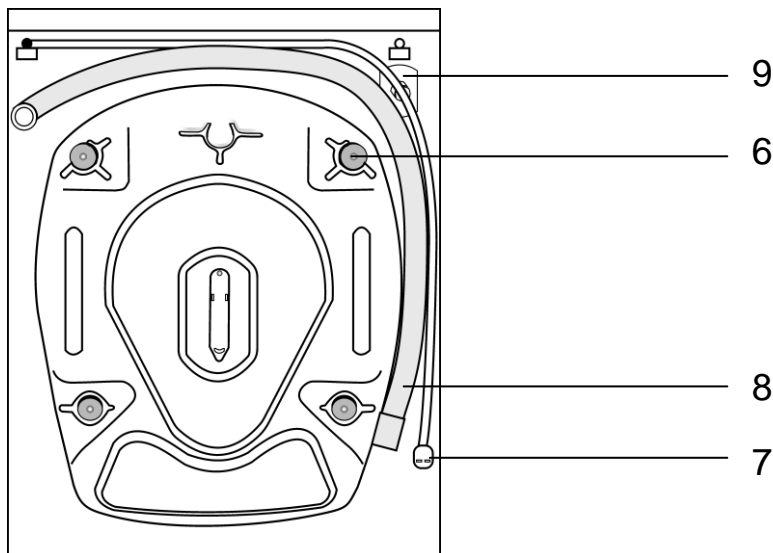

- 6. Transport bolt
- 7. Power cable
- 8. Discharging hose
- 9. Water inlet valve

Installation

Removing transportation bolts

Transportation bolts, which are located at the back of the machine, must be removed before using or running the machine.

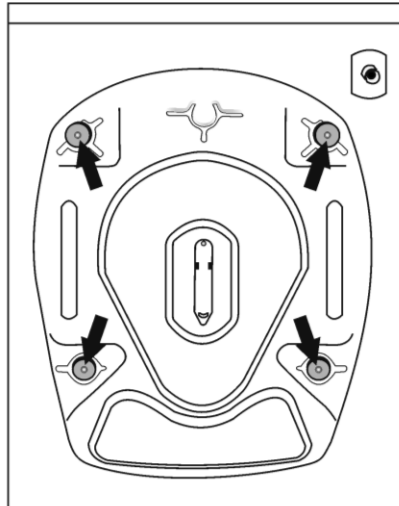

Loosen the bolts by rotating counterclockwise with a suitable spanner.

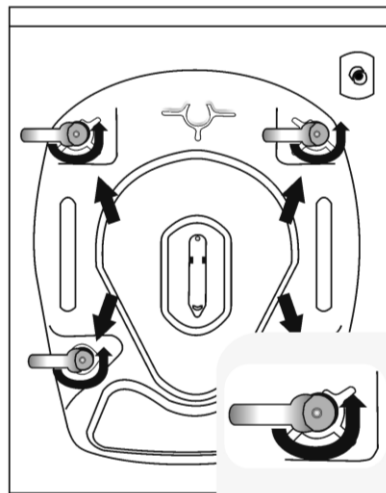

Pull out the bolts together with the coloured plastic spacer, (the screws that have been removed from the machine should be kept in case the machine needs to be used in future).

To seal the holes insert the supplied plastic caps.

Levelling the machine

- Your machine should be installed on a hard surface – do not install onto a carpet.
- For your machine to work quietly and without any vibration, it should be settled on a flat, non-slippery and tough ground.
- Loosen the plastic adjustment nut.

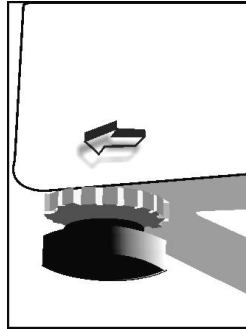

- Adjust the feet upward and downward by rotating them clockwise and anti clockwise.

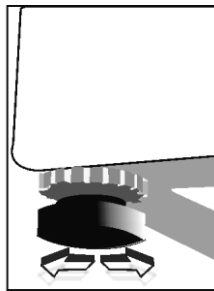

- When the correct balance has been achieved, tighten the plastic adjustment nut again by rotating it upwards.
- Never put cardboard, wood or other materials under your machine to try and stabilise the unit.

Electrical connection

- Your washing machine is set to 220-240V and 50Hz.
- The mains cord of your washing machine is equipped with a specific grounded plug. This plug should always be inserted to a grounded socket of 13 amps. The current value of the fuse should be 10 amps.
- **We do not take responsibility for any damage that occurs due to ungrounded usage.**
- Operating your machine under low voltage will cause the life cycle of your machine to be reduced and its performance to be restricted.

Water inlet connection

Only a qualified engineer should install this machine

- Your machine has a single water (cold) inlet.
- To prevent leakages on the connection joints, 1 seal is included in the hose packing, (Fit this seal on the end of the water inlet hose at the tap side.)
- Connect the bracketed end of the water inlet hose to the water inlet valve at the rear of the machine and the other end to your tap.
- Water pressure of 0,1-1 MPa from your tap will enable your machine to work more efficiently, (0,1 MPa pressure means water flow of more than 8 litres in 1 minute from a fully opened tap).
- After all connections are completed, check for leakages around the connection joints by turning on your tap completely and seeing if any water escapes.
- Be sure that water inlet hose is not folded, broken or crushed.
- Mount the water inlet hose to a 3”/4 geared water tap.

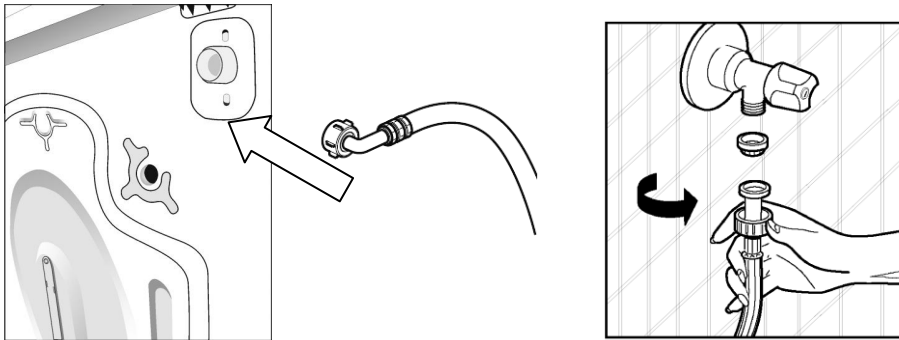

Water discharge connection

- Be sure that the water inlet hoses are not folded, twisted, crushed or elongated by stretching.
- The water drain hose should be mounted at a height of minimum 60 cm, maximum 100 cm from the ground.
- The end of the water drain hose can be fitted directly to the drainage hole.
- Never attempt to extend the water drain hose by adding extra parts.

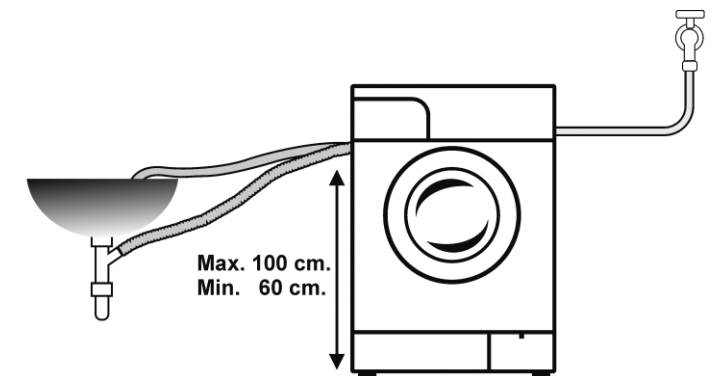

Technical specifications







| | |
|--|------------------------------------|
| Operating voltage / frequency (V/Hz) | (220-240) V ~/50Hz |
| Total current (A) | 10 |
| Water pressure (Mpa) | Maximum: 1 Mpa Minimum: 0.1 MPa |
| Total power (W) | 2200 |
| Maximum dry laundry capacity (kg) | 9 |
| Wringing revolution (rev / min) | 1200 |
| Programme number | 15 |
| Dimensions (Height x Width x Depth) (mm) | 845 x 597 x 582 |



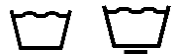











Preparing your laundry

- Separate your clothes according to their types (cotton, synthetic, sensitive, woolen, etc), washing temperatures, dirtiness and colour.
- Never wash your white and coloured clothes together.
- Since your new coloured clothes may shed dye on the first wash, wash them separately.
- Be careful that no metal pieces are found on or in the pockets of your clothes - remove if anything is found.
- Zip and button up your clothes.
- Remove the plastic or metal hooks and laces of curtains or place them inside a washing bag and tie.

WARNING: Faults that emerge due to the penetration of foreign objects into your machine are not included within the warranty.

- Reverse textiles such as pants, knitwear, t-shirt and sweat suit.
- Wash socks, handkerchief and suchlike small laundry items in a washing net.

| | | |
|---|---|--|
|  |  |  |
| Normal washing | Maximum washing temperature is 90°C | Maximum washing temperature is 60°C |
|  |  |  |
| Maximum washing temperature is 30 °C | Hand washing | No washing |

| | | |
|---|---|---|
|  |  |  |
| Whitening available | No whitening | Ironing temperature is maximum 110°C |
|  |  |  |
| Ironing temperature is maximum 150°C | Ironing temperature is maximum 200°C | No ironing |
|  |  |  |
| Dry cleaning available | No dry cleaning | Leave on a flat place |
|  |  |  |
| Hang when wet | Dry by hanging | Drying by twirling is not allowed |
|  |  |  |
| Dry cleaning in gas oil, pure alcohol and R113 is allowed | Perchloroethylene R11, R113, Petroleum | Perchlorinethylene R11, R113, Gas oil |

Using your machine

- Open the door of your machine.
- Place your laundry in your machine.

Note: Maximum loading capacity may vary based on the laundry type you wash, degree of contamination and the programme you have chosen. Do not exceed maximum dry loading capacity indicated in the programme table for washing programmes.

You can take the following table of weights as an indication.

| LAUNDRY TYPE | WEIGHT (Kg) |
|--------------|-------------|
| Towel | 0.2 |
| Linen | 0.5 |
| Bathrobe | 1.2 |
| Quilt cover | 0.7 |
| Pillow slip | 0.2 |
| Underwear | 0.1 |
| Tablecloth | 0.25 |

- Place each piece of laundry into the machine individually.
- Ensure that no laundry is caught between the cover and below the seal when closing the door of your machine.
- When closing the door, push the door of your machine until you hear the locking sound – this indicates the door is fully closed.
- Close the door of your machine properly; otherwise your machine will not start the washing operation.

Detergent

The amount of detergent needed per cycle will depend on the following criteria:

- Refer to detergent manufacturers guidelines to determining how much detergent is needed. Do not prewash your less stained laundry items and only put a slight amount of detergent in the 2nd compartment of the detergent drawer.
- For very dirty and stained laundry items, select a programme including prewashing, and put $\frac{1}{4}$ of the normal amount of detergent in the 1st compartment of the detergent drawer then put the remaining $\frac{3}{4}$ of it into the 2nd compartment.
- Use detergents produced for automatic washing machines in your machine. The amount of detergent you should use for your laundry is printed on the detergent package.
- The more hard the water used is, the more detergent you will use.
- The amount of the detergent you will use will increase as the amount of your laundry increases.
- Put the softener in the softener compartment in the detergent drawer. Do not exceed the MAX level. Otherwise, softener will flow into the washing water when flushing through.

- Softeners with a high density should be thinned to a degree before being put in the drawer. This is because high-density softener will clog the flush and avoid the flow of the softener.

Control Panel

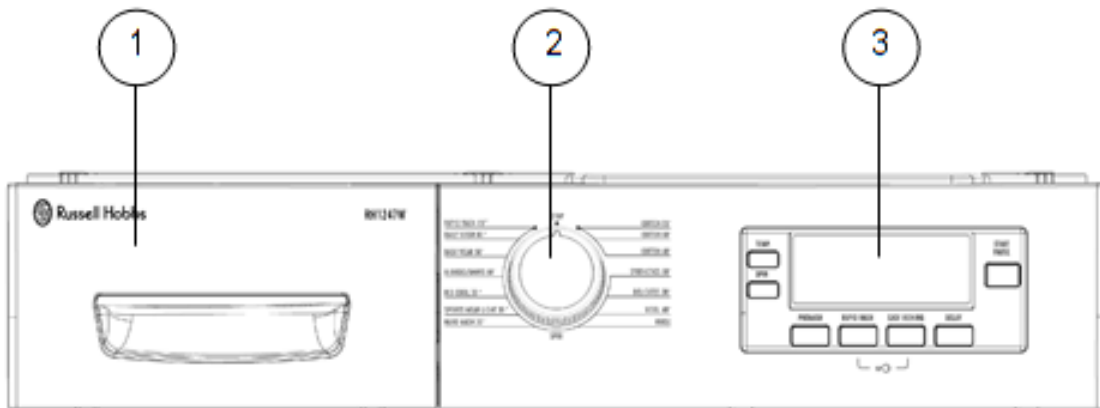

1. Detergent drawer
2. Programme knob
3. Electronic display and auxiliary functions

Detergent Drawer

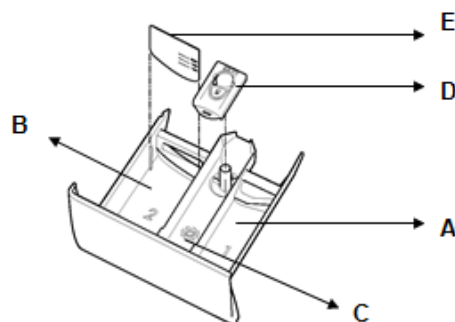

- A. Prewashing compartment
- B. Main washing compartment
- C. Softener compartment
- D. Siphon cover
- E. Liquid level detergent plate

Selecting a Programme

Select the required washing programme by rotating the programme knob in either direction (clockwise or anti-clockwise). Ensure that the programme knob is aligned with the required programme.

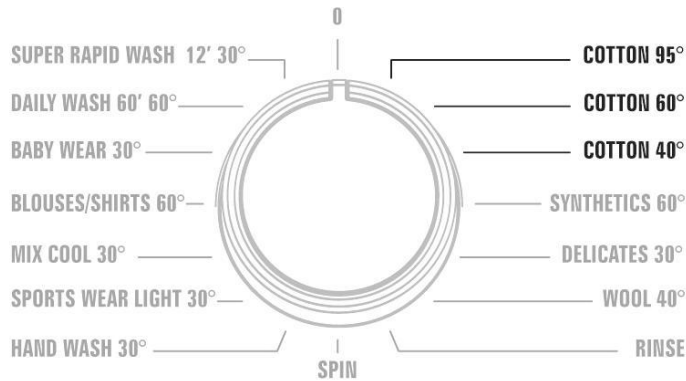

Electronic Display

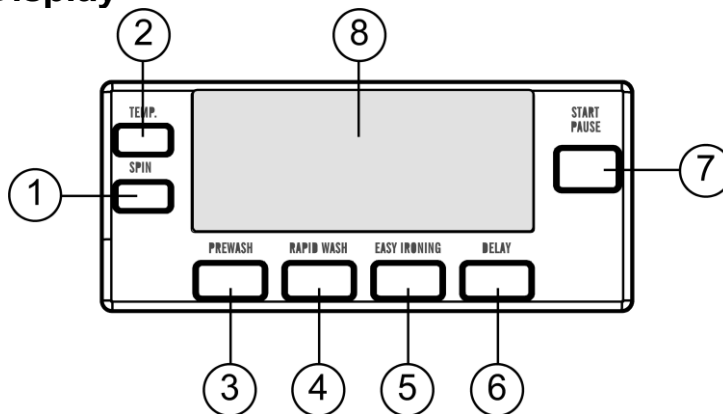

1. Spin speed select
2. Temperature select
3. Prewash function
4. Rapid wash function
5. Easy iron function
6. Delay timer function
7. Start/Pause button
8. Electronic display

On the electronic display, you can view the water temperature, spin speed of your machine, the amount of time your machine will continue washing, additional functions you have selected and whether the door of your machine is locked or not.

Furthermore, the electronic display will warn you by means of fault symbols on the display when a fault occurs on your machine and notify you of the completion of the washing programme by displaying the text "END" on the display as soon as the washing programme you have selected has finished.

Using your machine

Before Use

- Plug your machine in.
- Turn on the tap connected to your machine.
- Open the machine door.
- Place your laundry in your machine.
- Push the door of your machine until hearing the locking sound to close it.
- Select the program you require.
- Put detergent and softener in the detergent drawer.

First Wash

Before using the machine for laundry, ensure you run the machine on a cycle of 95°C, with detergent and without laundry.

Selecting a Programme

Select the appropriate programme for your laundry from the programme table below.

Additional Functions

Before starting the programme, you can select an additional function if you so wish.

- Press on the button of the additional function you wish to select.
- If the additional function symbol on the electronic display flashes continuously, the function you have selected will be activated.
- If additional function symbol on electronic display **blinks**, the function you have selected will not be activated.
- If an additional function fails to activate, this is because not all additional functions are available with all programmes.

Half Load Detection

Your machine features a half-load detection system. If you only put laundry into the machine that is approximately half or less than half of the maximum laundry capacity stated for your machine, your machine will run so as to save washing time, water consumption and energy in some programmes (Cotton 95°, Cotton 60°, Cotton 40°). When half-load function is active, the machine can complete the programme you have set in a shorter time.

Twinjet system

Water and detergent from your machine will be circulated with 2 water injection mechanisms and a mixing system via a twin jet system. Circulated water will be injected over your washing which allows a better washing performance.

The twin jet system will allow you to wash a higher amount of laundry in a shorter time which will guarantee less water and electricity consumption.



Twin jet system in operation

| Programme selection | | | | |
|---|----------------------------------|------------------------------|---|--|
| PROGRAMME & PROGRAMME TEMPERATURE (°C) | PROGRAMME DURATION (MIN.) | DETERGENT COMPARTMENT | MAXIMUM AMOUNT OF DRY LAUNDRY (kg) | LAUNDRY TYPE |
| COTTON 95° | 190 | 2 | 6 | Very dirty cotton and flax textiles. (Underwear, linen, tablecloth(s), towel(s) (maximum 4 kg), bedclothes, etc. |
| COTTON 60° | 200 | 2 | 6 | Normal dirty cotton and flax textiles. (Underwear, linen, tablecloth(s), towel(s) (maximum 4 kg), bedclothes, etc. |
| COTTON 40° | 170 | 2 | 6 | Normal dirty colour and flax textiles. |
| SYNTHETICS 60° | 101 | 2 | 3.5 | Very dirty synthetic or synthetic-mixed textiles. (Nylon socks, shirts, blouses, synthetic-including trousers etc.) |
| DELICATES 30° | 91 | 2 | 2.5 | Less dirty silk-mixed laundries with machine wash labels |
| WOOL 40° | 78 | 2 | 2.5 | Woollen laundries with machine wash labels (PLEASE CHECK EACH INDIVIDUAL CLOTHING ITEM'S LABEL – ADJUST TEMPERATURE IF NECESSARY). |
| RINSE | 36 | - | 7 | If you want to additionally rinse your laundry after a program has finished, you can use this programme for any kind of laundries. |
| SPIN | 15 | - | 7 | If you want to additionally wring your laundry after a program has finished, you can use this programme for any kind of laundries. |
| HAND WASH 30° | 90 | 2 | 2.5 | Sensitive and woollen laundries with non-machine wash labels, that are recommended to be washed by hand. |
| SPORTS WEAR LIGHT 30° | 74 | 2 | 3.5 | Sportswear items which are mainly made of special fibers, (in particular a synthetic kind), that the washing label recommends that they should be washed sensitively under a low temperature. In that way, the speciality of sportswear textile, badges, wording, etc should be protect during the washing process. |
| MIX COOL 30° | 109 | 2 | 3.5 | Suitable for mixed items of laundry made of cotton and easy-care fabrics sensitive to heat. The program temperature and mechanical agitation is designed to be appropriate to both normal dirty cotton, flax and synthetic based laundry. |
| SHIRTS/BLOUSES 60° | 108 | 2 | 3.5 | You can use this program to wash shirts made from cotton, synthetic and synthetic blended fabrics which need to be washed on a lower temperature than synthetics, and gentler than cottons. |
| BABY WEAR 50° | 182 | 2 | 5 | Baby clothes are delicate and baby skin is really reflective to detergent, this program has an extra rinse with heating which purifies laundry from detergent. Although program has heating step in the main wash, it also applies heating during rinses and it helps to get rid of stains, odors and some microorganisms. |
| DAILY 60° 60' | 60 | 2 | 3 | You can wash your dirty cotton, colour and flax textiles at 60°C in 60 minutes |
| SUPER RAPID 30° 12' | 12 | 2 | 2 | You can wash your dirty cotton, colour and flax textiles in 15 minutes. Note: As the washing period is short, a less amount of detergent is required to be used compared to other programmes. The programme period will increase if your machine detects instable loading. |

Note: You can open the door of your machine 2 minutes after the completion of washing operation. (The duration of 2 minutes required to open the door of your machine is not included in the washing period).

Additional Functions

1. Spin Speed

1. Spin speed selection and additional functions

You can set the spin speed for your laundry via the spin speed setting button.

When you select a new programme, the maximum spin speed of the programme you have selected will be shown on the electronic display.





You can gradually reduce the spin speed by pressing the spin speed setting button. The spin function of the program can be cancelled by pressing the spin speed button until (--) spin symbols are shown on the electronic display.

If you have missed the required spin speed, you can return to the intended spin speed by continuously pressing the spin setting button.

To minimise creasing, use the additional rinse function.



In programmes where the rinse function is applicable, it may be activated by pressing the spin speed setting button one more time after the cancel (--) spin symbol is shown on the electronic display. You know that the soaking function is activated when the symbol  flashes on electronic display.

If the extra rinse function is selected, your laundry will be soaked in the last rinsing water. When your machine soaks your laundry in the last rinsing water, symbol  will blink on electronic display.

To remove laundry, press the “Start / Pause” button. Your machine will empty the remaining water and finish the programme without spinning.

To spin your laundry:

- a) You can select the spin speed by using the spin speed setting button when your machine is soaking your laundry in the latest rinsing water. If you want to take your laundry out, press on “Start / Pause” button. Your machine will

empty the remaining water and finish the programme once the spin function is complete.

- b) Switch the programme knob to 'Stop', select the spin programme on the programme knob. You can choose to reduce the spin speed by pressing the spin speed setting button. You can start your machine by pressing on Start/Pause button. Your machine will finish the programme after spinning your laundry in the spin revolution you have selected.

2. Temperature selection

You can select the washing water temperature with the temperature adjustment button.



When you select a new programme, the maximum temperature is shown on the electronic display.

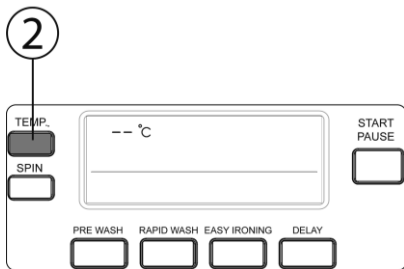

You can gradually decrease the washing water temperature between the maximum temperature and cold washing (--) by pressing washing water temperature adjustment button.

If you have missed the washing water temperature you wanted, you can return to the intended temperature by continuously pressing the washing water temperature adjustment button.

3. Pre Wash

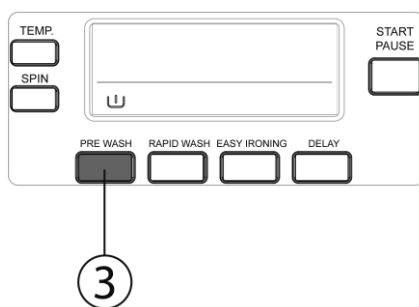

You can give your very dirty laundry a prewash prior to the main wash by using this additional function. When using this function, you should put detergent in the front washing compartment of the detergent drawer.

4. Rapid Wash

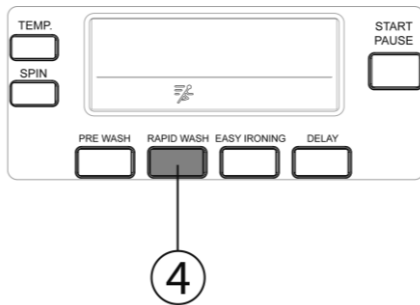

This additional function will enable the washing duration of your less dirty laundry to be shortened. If you put laundry in that only makes up half or less than half of the laundry capacity of the washing programme you have selected in your machine, your machine will automatically detect this due to the 'Half-load' detection system, and the programme you have selected will wash your laundry in a shorter time to consume less energy and water. If your machine detects a half load, the symbol  will automatically flash on the electronic display. To cancel it, press the rapid wash function button once. However, the rapid wash function cannot be selected if you have selected the main rapid wash programme with the programme knob.

5. Easy Iron

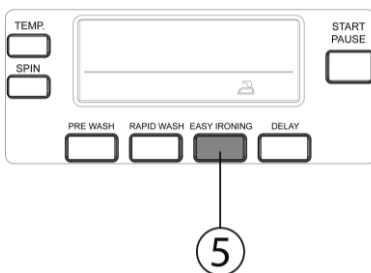

Your laundry will be less creased if the easy ironing function is pressed/selected.

6. Delay Timer

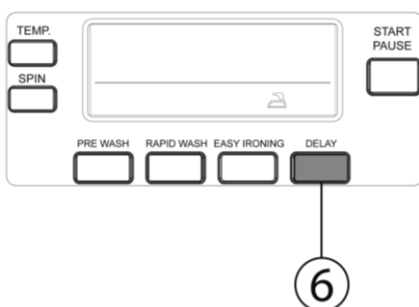

By using this function, you can delay the start of your washing programme by 30 minutes up to 23 hours.

To use the delay timer function:

- Press the time delay button once.
- "0.5h" will appear on the display.
- Press the time delay button until the time of which you want the washing programme to be delayed by is shown on the electronic display.

- To activate the time delay of the programme you have selected, you should press the “Start/Pause” button and the time delay will start to count down.

The time Intervals of the delay timer is 30 minutes for the first 2 hours, thereafter it is 1 hour up to 23 hours.

If you have missed the time delay you wanted, you can go back to the time desired by continuously pressing the delay timer button.

If you want to cancel the delay timer, you need to press and hold the delay timer button for 2 – 4 seconds.

To run the delay timer function, your machine needs to be operated by pressing on Start/Pause button. As soon as you start your machine, the countdown process will start on the electronic display based on the delay period you have selected.

Anti-Allergy Function

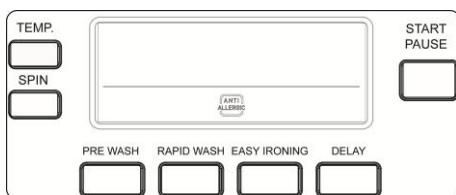

In the programmes where this function is active, your machine will perform an extra rinsing operation on your laundry prior to the last rinsing operation.

Note: The anti-Allergy function is selected automatically only in Baby wear programme.

Start/Pause button

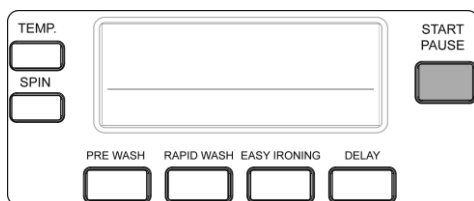

By pressing the Start/Pause button, you may start the programme you have selected or suspend a running programme. If you pause a cycle, the electronic display will blink.

When you start your machine, the following symbols for the programmes you have selected will be available on the electronic display.

- Temperature of washing water
- Spin speed
- Symbols of auxiliary functions (if you have selected)
- Programme ending time or programme delay time based on your selection
- Open or locked door symbol

Note: Symbol for open door flashing on electronic display will go off and symbol for locked door will flash approximately 1 minute after you start your machine by pressing the Start/pause button.



Open



Closed

Adding/Removing Laundry

If you want to add or remove laundry when your machine is running:

- Switch your machine to the pause mode by pressing on Start/Pause button.



- After a while, the symbol  will be shown on the electronic display and this means that the door of your machine can now be opened.



- When you see the symbol  appears on the electronic display, you can either add or remove laundry after opening the machine door.

Note: If symbol  blinks on the electronic display, it means that you cannot add or remove laundry as the cycle has started.

- When you have added or removed the laundry, close the door of your machine and press on Start/Pause button.

- Your machine will continue to wash after locking the door of your machine.

- The symbol  will flash on the electronic display.



Child Lock

A child lock prevents the interruption of a cycle when buttons are pressed and the knob is turned. The Child lock will be activated when both the rapid wash and easy ironing buttons are pressed at the same time for 3 seconds or longer.



The symbol  will flash on the electronic display when the child lock is activated.

If any button is pressed while the child lock is active, the symbol  will blink on the electronic display.

When any of the programmes are running and the child lock is active, if another programme is selected after programme knob is switched to the Stop position, the programme already running will continue.

To deactivate the Child Lock, both the rapid wash and easy ironing functions should be pressed at the same time for 3 seconds or longer. When Child Lock is

deactivated, symbol  on the electronic display will go off.

Cancelling a Programme

If you want to cancel any programme running:

- Switch the programme knob to Stop.
- Your machine will stop the washing operation and the programme will be cancelled.
- To get rid of the water accumulated in the machine switch the programme knob to any programme.
- Your machine will perform the necessary discharge operation and cancel the programme.
- You can re start your machine by selecting a new programme.



Programme End

Finishing programme

- Your machine will stop by itself as soon as the programme you have selected finishes.
- The text “END” will flash on the electronic display.



Note: Within 2 minutes of the programme finishing, your machine will remove the “End” text from the electronic display to save energy. It will re-flash when any of the additional function buttons are pressed.

- 
- If you see that the symbol  indicating that the door can be opened flashes on the electronic display, you can open the door of your machine and remove the laundry.

- Leave the door of your machine open to allow the inner part of your machine to dry after removing your laundry.
- Switch the programme knob to Stop.
- Unplug your machine.
- Turn the water faucet off.

Warning Symbols

Water cut off / Low Mains Pressure

If the symbol  flashes on the electronic display:

- The water supply may be closed.
- Mains water may be cut-off. If so, switch the programme knob to position 0. You can select a programme and run your machine after the mains water is flowing again.
- Mains water pressure may be low.
- Water inlet hose may be twisted.
- Water inlet hose may be clogged. Clean water inlet hose filters. (*)
- Valve inlet filter may be clogged. Clean the valve inlet filters. (*)

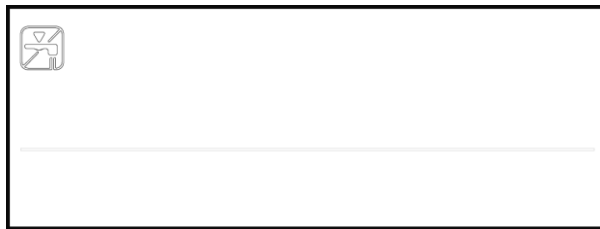

(*) See the chapter regarding maintenance and cleaning of your machine.

Blocked pump filter

If the symbol  flashes on the electronic display:

- Pump filter may be clogged.
- Discharging hose may be clogged or twisted.

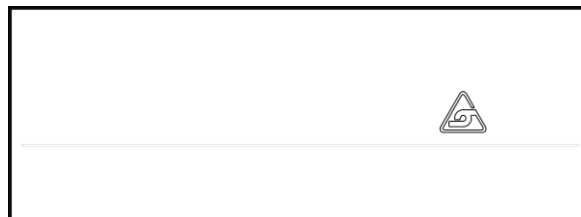

Maintenance and Cleaning

When cleaning your machine, ensure that the machine is unplugged and the water supply is closed off.

Water Inlet Filters

Filters are used to avoid dirt and foreign substances in the water from entering the machine. These are on the tap and on the ends of water valves along the water inlet hose of your machine. If your machine cannot intake sufficient amounts of water despite the tap being open, these filters should be cleaned.

- Detach the water inlet hoses.
- Remove the filters on water inlet valves using pliers and then clean it with a brush in water.
- Disassemble the filters on the tap end of the water inlet hoses manually and clean it.
- Having the filters cleaned, you can fit them in the same way reversely.

CAUTION: Filters of water inlet valves may be clogged due to a contaminated water tap or lack of necessary maintenance or valves may be broken down, causing water to leak into your machine continuously. **Breakdowns that may arise because of these reasons are not covered under warranty.**

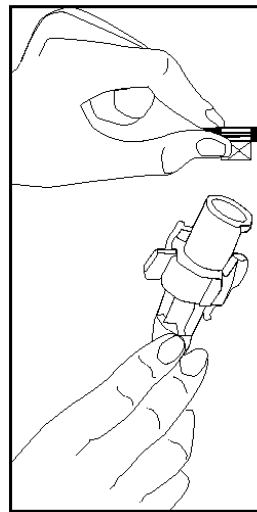
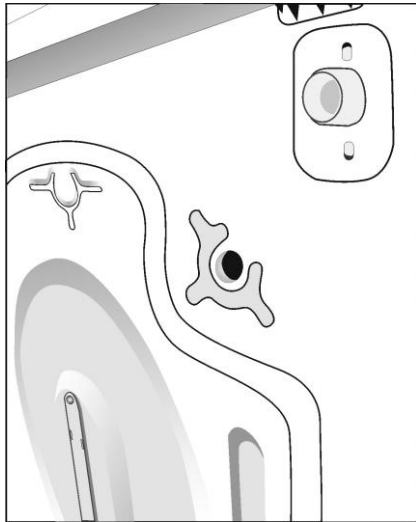

Cleaning the pump

A filter system is available which avoids threads from your laundry and tiny materials from entering into the pump during the water discharging operation carried out by your machine after completing washing. This prolongs the lifecycle of your pump. It is recommended that you clean your pump filter once in 2 months. To clean pump filter:

- Depress the lug downwardly to uncover the pump section of the toe board and pull it towards yourself and extract it.

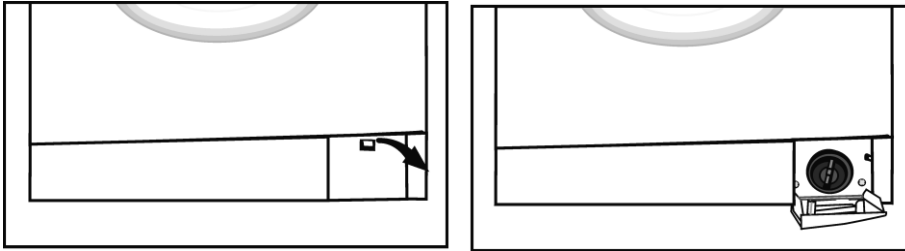

- Before opening the filter cover, place a towel on the ground immediately in front of the filter hole to soak up remaining water.

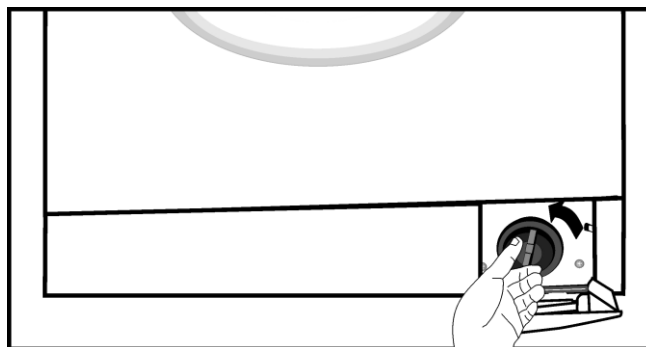

- Loosen the filter cover in and allow water to flow out.
- Clean the foreign objects present in the filter.
- Check whether the pump rotates with your hands.
- After cleaning the filter, fit the filter cover by rotating it clockwise.
- Fit the pump section of the toe board.
- Remember that water will leak if you do not fit the filter cover properly.

WARNING!

As water in the pump may be hot, do not remove the filter cover until the machine has had sufficient time after a cycle to cool down.

Cleaning the detergent drawer

Your detergent may deposit residue in the detergent drawer over time. To clean the residue formed, disassemble the detergent drawer regularly. To eject the detergent drawer:

- Pull the detergent drawer out fully.

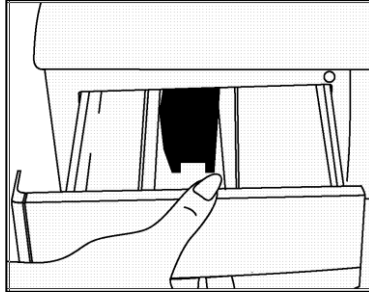

- Continue to pull gently while pressing the detergent cover to allow the drawer to slide out.

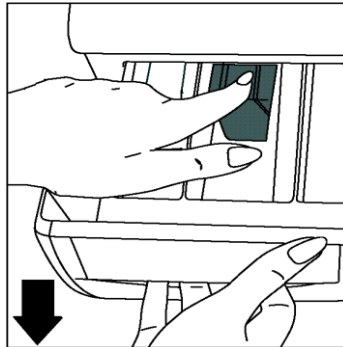

- Flush it using a brush.
- Collect residues in the housing of the detergent drawer without dropping them inside the machine.
- To assemble the detergent drawer after drying it using a towel or dry cloth, resettle the detergent drawer by depressing on the flush cover and fit it by pushing forward.
- **Do not wash your detergent drawer in a dishwasher.**

Cleaning your machine

Drawer filter

Disassemble the detergent drawer. Disassemble the flush stopper and clean the softener residues completely. Refit the flush stopper after cleaning it. Check whether it has settled properly.

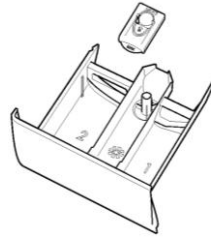

Body

Clean the outer body of your machine with warm water and a non-inflammable cleaning agent that will not abrade the body of your machine. After rinsing with some water, dry using a soft and dry cloth.

Drum

Do not leave metallic objects such as needles, paper clips, coins, etc. in your machine. These objects will lead to formation of rust stains in the drum. To clean such rust stains, use a non-chlorine cleaning agent and follow the instructions of the manufacturers of the cleaning agent. Never use wire wool or similar hard objects for cleaning rust stains.

Trouble Shooting

All repairing operations required for your machine should be carried out by a qualified engineer. Contact an engineer on **01204 664 084**. If your machine requires a repair or if you cannot remove the fault by the help of the information provided as follows:

- Unplug your machine.
- Turn the tap off.
- Contact the nearest authorised service.

| FAULT | POSSIBLE CAUSE | REMOVING METHODS |
|--|--|---|
| Your machine does not discharge water. | Discharging hose clogged or twisted. | Check the discharging hose. |
| | Pump filter clogged. | Clean the pump filter. |
| | Laundry settled in the machine unevenly. | Spread your laundry in the machine evenly. |
| Your machine vibrates. | The feet of your machine have not been adjusted. | Adjust the feet on your machine. |
| | Safety assembly fitted for transport not disassembled. | Disassemble the safety assembly of your machine. (**) |
| | Less amount of laundry in the appliance. | This will not block operation of your machine. |
| | Your machine overloaded with laundry or laundry | Do not put in laundry more than the amount |

| | | |
|--|---------------------------------------|---|
| | settled unevenly. | recommended and settle the laundry in the machine evenly. |
| | Your machine rests on a hard surface. | Prevent your machine from resting on hard surfaces. |

| FAULT | POSSIBLE CAUSE | REMOVING METHODS |
|-------------------------------------|--|--|
| Your machine does not start. | It is not plugged in. | Plug machine in. |
| | Fuse blown. | Replace the fuse. |
| | Electricity cut-off. | Check mains power. |
| | Start/pause button not pressed. | Press on start/pause button. |
| | Programme knob 'stop' position. | Switch the programme knob to the desired position. |
| | The machine door is not completely closed. | Close the machine door. |
| Your machine does not intake water. | Water tap is turned off. | Turn your faucet on. |
| | Water inlet hose may be twisted. | Check water inlet hose. |
| | Water inlet hose clogged. | Clean water inlet hose filters. |
| | Valve inlet filter clogged. | Clean the valve inlet filters. |
| | The machine door is not completely closed. | Close the machine door. |

| FAULT | POSSIBLE CAUSE | REMOVING METHODS |
|---|-------------------------------------|--|
| Excessive foam is formed in the detergent drawer. | Excessive amount of detergent used. | Press on Start/Pause button. To eliminate foam formation, mix a spoon of softener with half litre of water, and pour the mixture in the detergent drawer. After 5-10 minutes, press on Start/Pause button again. For next washing operation, decide the dose of detergent as required. |
| | Wrong detergent used. | Use detergents produced only for automatic washing machines in your machine. |

| | | |
|--------------------------------|---|---|
| Unsatisfactory washing result. | The dirtiness of your laundry does not match the programme you have chosen. | Select the programme appropriate for correct dirtiness of your laundry. (see programme table) |
| | Amount of detergent used insufficient. | Adjust the amount of detergent based on the dirt level of your laundry. |
| | Laundry in excess of maximum capacity put in your machine. | Load your machine with laundry, amount of which should not exceed maximum laundry capacity |



Error Messages

Your machine is equipped with systems that continually self-check during washing operations and then take the necessary precautions and warn you in case of any breakdown.

| TROUBLE CODE | POSSIBLE FAULT | WHAT TO DO |
|--------------|--|---|
| E01 | The door of your machine is left open. | Close the machine door. If your machine persists to indicate fault, turn off your machine, unplug it and contact the nearest authorised service immediately. |
| E03 | Pump is faulty or pump filter is clogged or electrical connection of the pump is faulty. | Clean the pump filter. If the problem persists, contact the nearest authorised service. (*) |
| E04 | Your machine has an excessive amount of water. | Your machine will discharge water by itself. After the discharging operation, turn off your machine and unplug it. Turn off your faucet and contact the nearest authorised service. |

(*) See the chapter regarding maintenance and cleaning of your machine.

Warning symbols

| TROUBLE CODE | POSSIBLE FAULT | WHAT TO DO |
|---|---|---|
|  | <p>Water cut-off or low mains water pressure.</p> | <ul style="list-style-type: none"> - Tap may be off. - Mains water may be cut-off. - If so, switch the programme knob to position 0. You can select a programme and run your machine after the mains water is supplied. - Mains water pressure may be low. - Water inlet hose may be twisted. - Water inlet hose may be clogged. - Clean water inlet hose filters. - Valve inlet filter may be clogged. - Clean the valve inlet filters. <p>If the problem persists, unplug your machine, turn off your faucet and contact the nearest authorised service.</p> |
|  | <p>Pump is faulty or pump filter is clogged or electrical connection of the pump is faulty.</p> | <ul style="list-style-type: none"> - Pump filter may be clogged. Clean the pump filter. - Discharging hose may be clogged or twisted. Check the discharging hose. <p>If the problem persists, contact the nearest authorised service.</p> |

Energy Efficiency

Energy and water consumption may vary based on water pressure, water hardness, water temperature, ambient temperature, laundry amount, additional function selection, and voltage fluctuations.

It will reduce energy and water consumption to use your machine with the laundry capacity proposed for the selected programme, wash your less dirty or daily laundry in short programmes, carry out cleaning and maintenance periodically, use your machine at the convenient time intervals specified by electricity vendor.

For manufacturer's warranty
information please call

01204 664 084

Opening times:

Monday - Friday

9am until 5pm

Saturday: 9am – 1pm

Alternatively, write to:

PO Box
2235
Bolton
BL6 9AJ

Revision 1

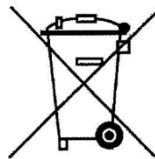

This symbol is known as the 'Crossed-out wheeie bin Symbol'. When this symbol is marked on a product/batteries, it means that the product/batteries should not be disposed of with your general household waste. Only discard electrical/electronic/battery items in separate collection schemes, which cater for the recovery and recycling of materials contained within. Your co-operation is vital to make sure the success of these schemes and for the protection of the environment. For your nearest disposal facility, visit www.recycle-more.co.uk or ask in store for details.

We reserve the right due to possible changes to design to alter the instruction manual without prior notice.